

Greinatöflur T.1-T.32

550x300x160

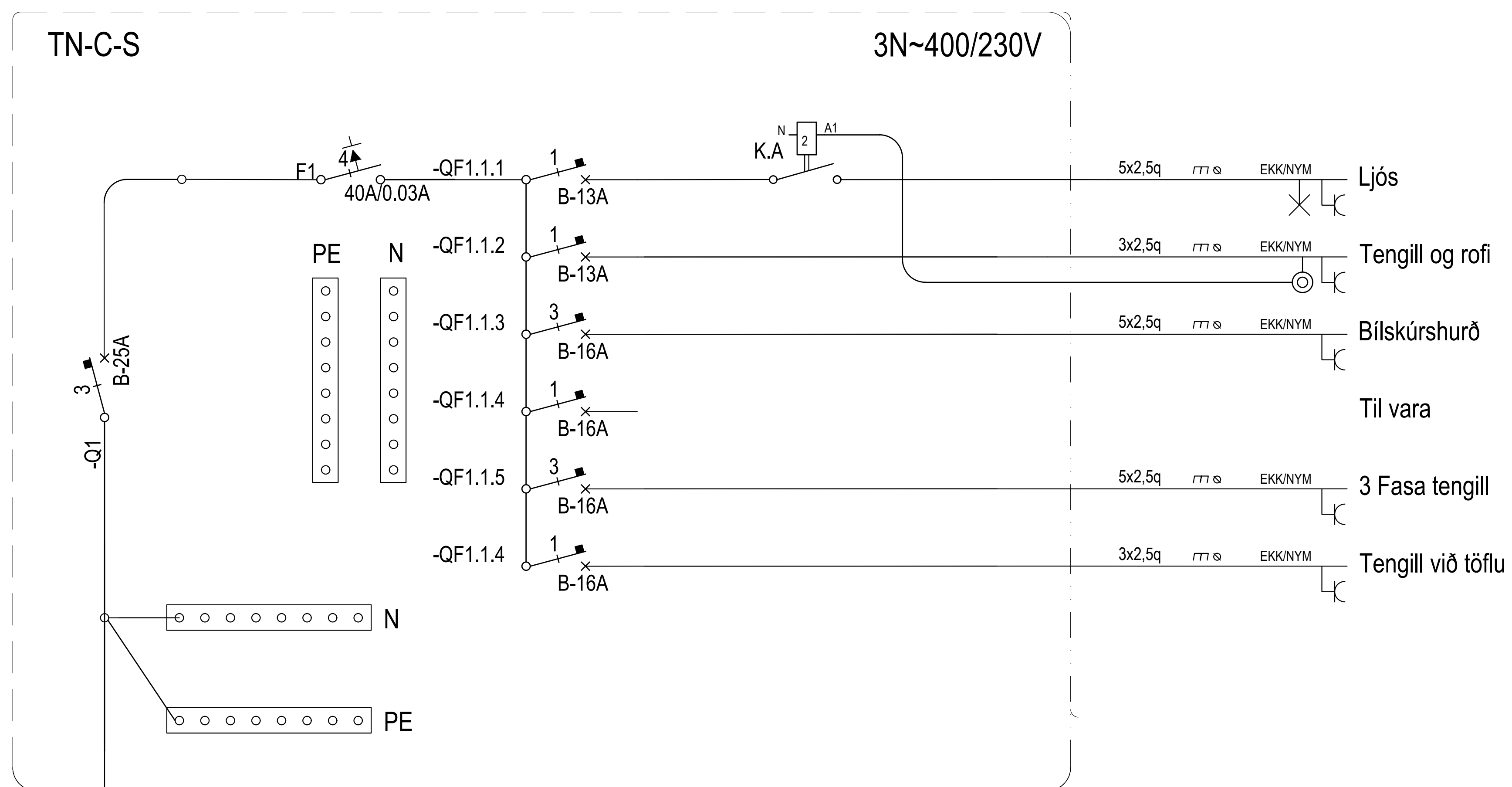

Stofn frá T.0
 3x400/230V 3x35A

ÚTG.	DAGS.	ÚTGAFUFERILL	HANNAÐ	TEIKN.	YFIRF.

TÆKNISÝN
 Rafagnateikningar og hönnun
 Kt: 251191-2639
 Sími: 846-7203
 Rafteikningar@gmail.com

Geymslur
 Stálhella 18
 221 Hafnarfjörður

Rafkerfi
 Einlínnumynd
 T.1-T.32

HANNAÐ:	TEIKNAD:	YFIRFARID:
Arnar Bjarnason	Arnar Bjarnason	Arnar Bjarnason
DAGS. ÚTG:	MÆLIKVARDI:	BLAÐSTÆRD:
06-02-2025	XX	A1
VERKNUMER:	TEIKNINGANUMER:	ÚTG:
09-25	XX_11_03	A

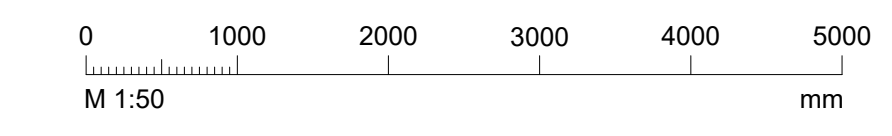

C:\Users\arnar\Dropbox\Gæðakerfi\12 Rafagnateikningar\Verkefnauppgjafir\2025\06-25 (Stálhella 18)\05 Teikningar\26 Blin hús\Einlínnumynd.dwg

1/00A

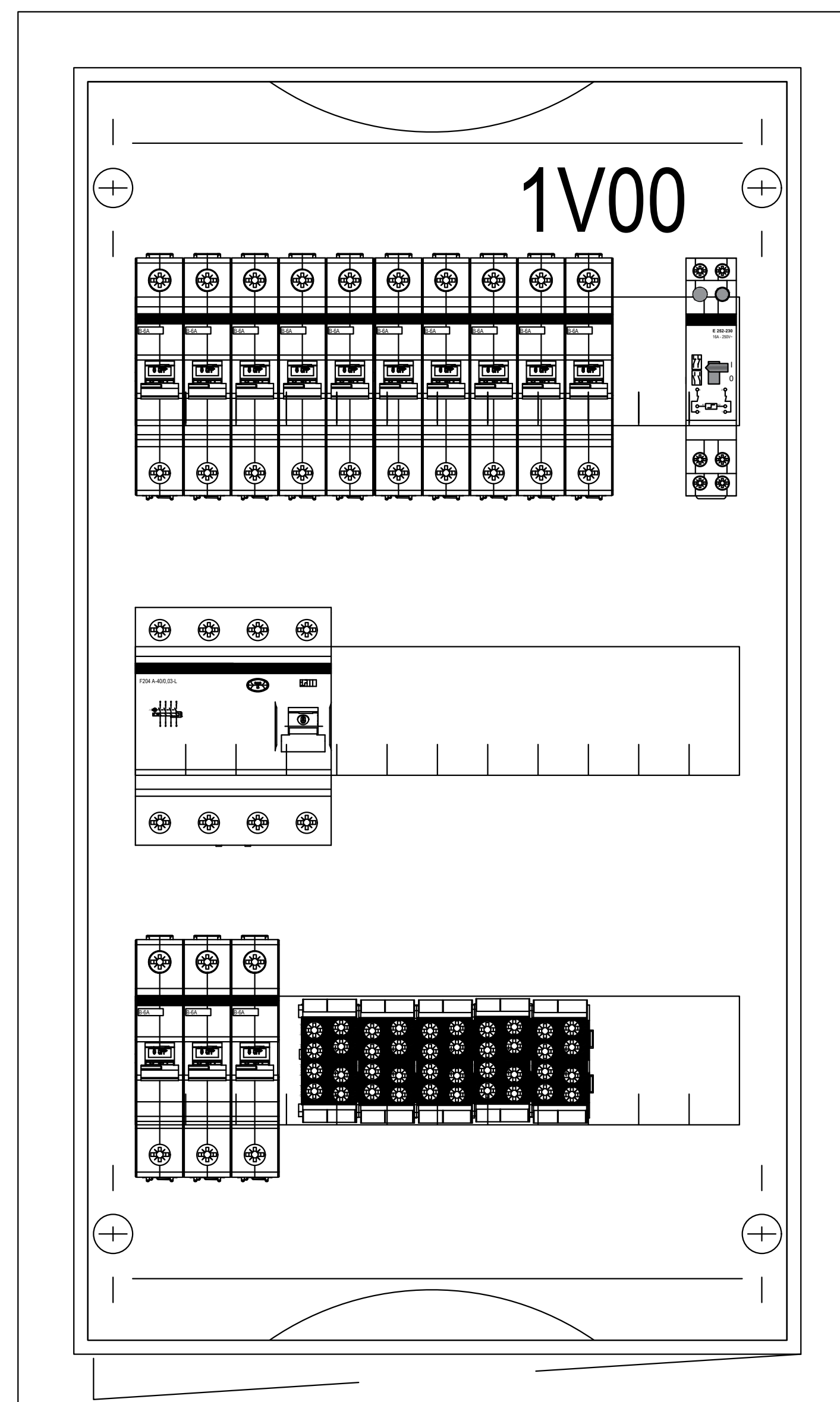

Hæð: 500mm
 Breidd: 300mm
 Dýpt: 215mm

ÚTG.	DAGS.	UTGAFUFERILL	HANNAÐ	TEIKN.	YFRF.

TÆKNISÝN
 Raflagnateikningar og hönnun
 Kt: 251191-2639
 Sími: 846-7203
 Raflaekningar@gmail.com

Geymslur
 Stálhella 18
 221 Hafnarfjörður

Raferfi
 Töflumynd
 T0.0

HANNAÐ:	TEIKNAD:	YFIRFARID:
Arnar Bjarnason	Arnar Bjarnason	Arnar Bjarnason
DAGS. ÚTG:	MÆLIKVARDI:	BLAÐSTÆRD:
06-02-2025	XX	A1
VERKNUMER:	TEIKNINGANUMER:	ÚTG:
09-25	XX_12_02	A

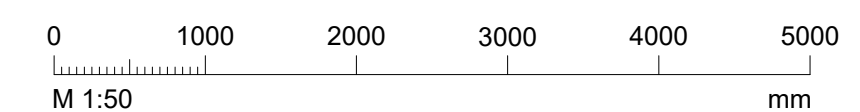

C:\Users\arnar\Dropbox\Gæðakerfi\12 Raflagnateikningar\Verkefnauppgjafir\09-25 Stálhella 18\05 Teikningar\06 Blm hlaErfilmmynd.dwg

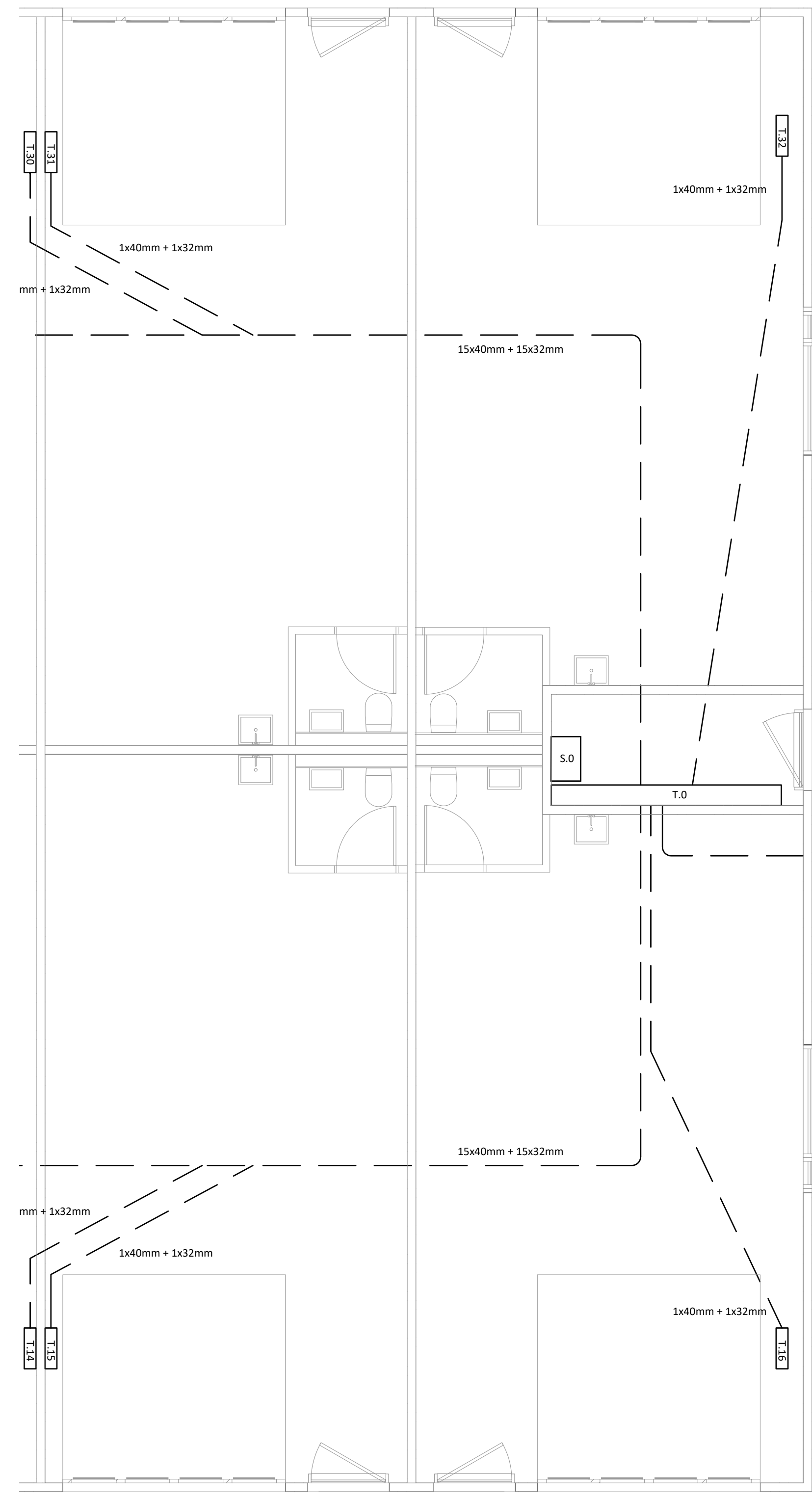
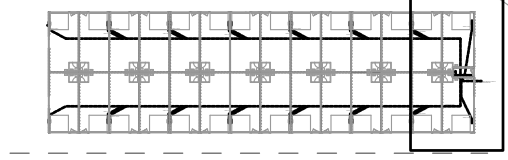

HEIMTAUG RAFMAGNS OG SÍMA 1x110 + 1x50mm rör
 LAGT AÐ LOBARMÖRKUM A 70CM DYPI

ÚTG.	DAGS.	ÚTGAUFERILL	HANNAÐ TEIKN. YFIRF.
-	-	-	-
-	-	-	-
-	-	-	-
-	-	-	-
-	-	-	-
-	-	-	-
-	-	-	-
-	-	-	-
-	-	-	-
-	-	-	-

TÆKNISÝN
 Rafagnateikningar og hönnun
 Kt: 251191-2639
 Sími: 846-7203
 rafteikn@rafteikn.is

Geymslur
 Stálhella 18
 221 Hafnarfjörður

Rafkerfi
 Lagnaleiðir
 Hluti 3

HANNAÐ:	TEIKNAD:	YFIRFARID:
Arnar Bjarnason	Arnar Bjarnason	Arnar Bjarnason
DAGS. ÚTG:	MÆLIKVARDI:	BLADSTÆRB:
06-02-2025	1:50	A1
VERKNUMER:	TEIKNINGANUMER:	ÚTG:
09-25	01_14_03	A

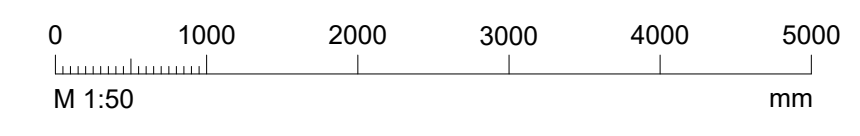

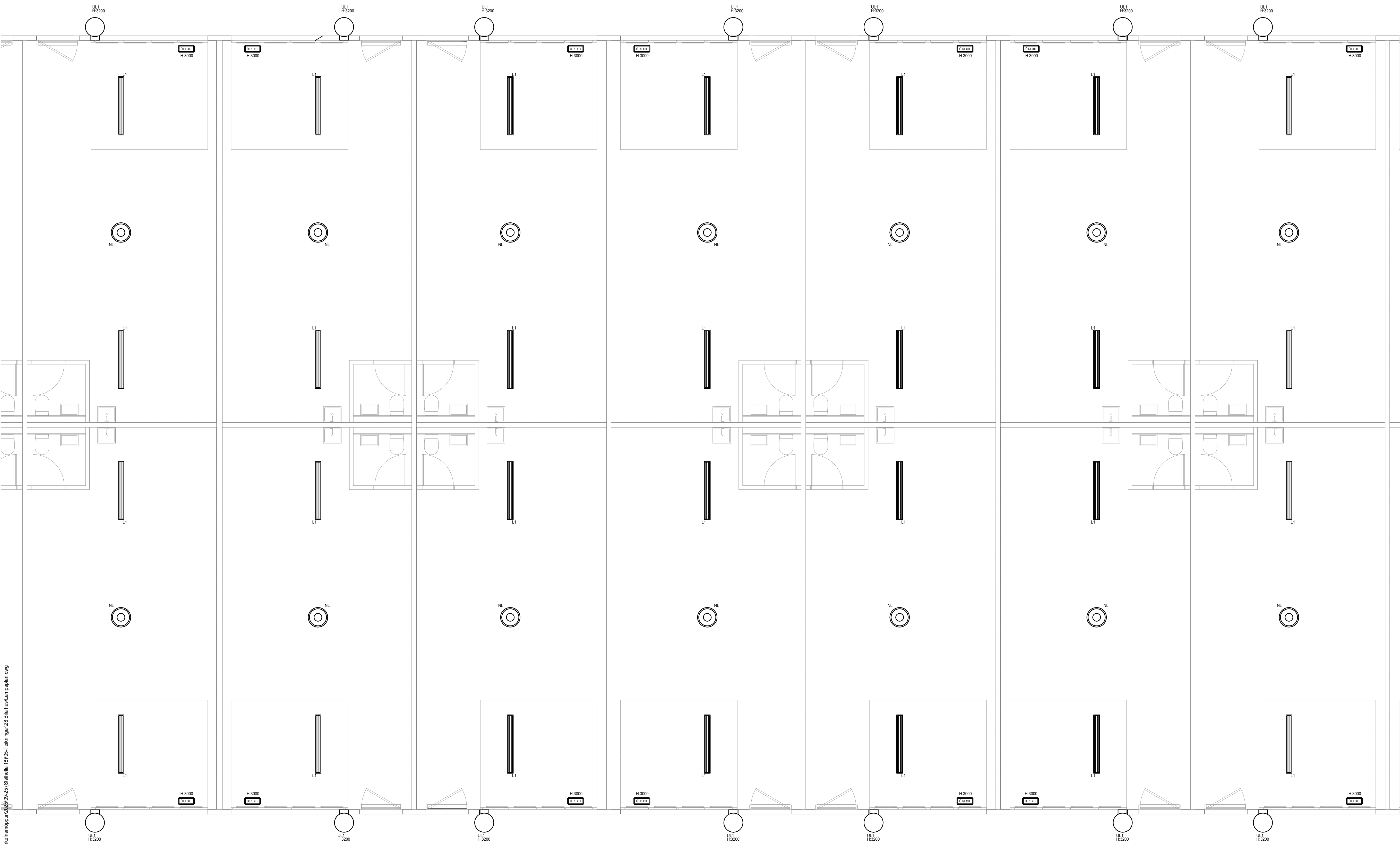
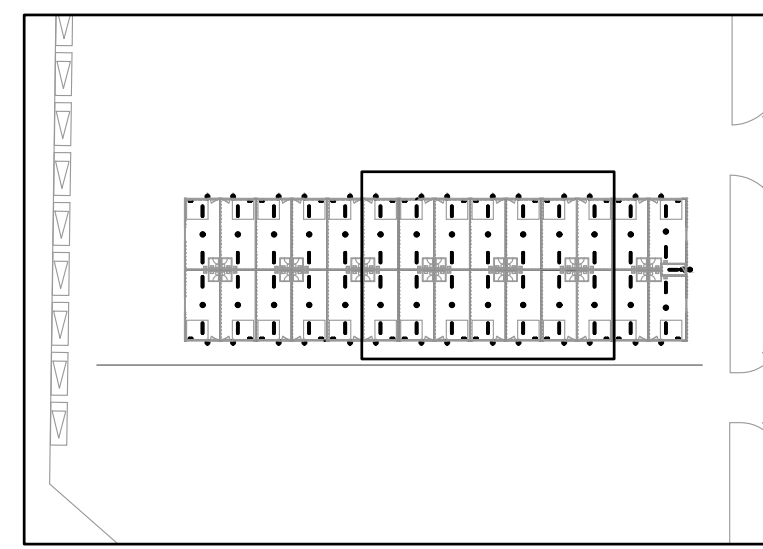

Hönnunarefni: ...

ÚTG.	DAGS.	ÚTGAUFERILL	HANNAÐ TEIKN. YFIRF.
---	---	---	---
---	---	---	---
---	---	---	---
---	---	---	---
---	---	---	---
---	---	---	---
---	---	---	---
---	---	---	---
---	---	---	---
---	---	---	---

TÆKNISÝN
 Rafagnateikningar og hönnun
 Kt: 251191-2639
 Sími: 846-7203
 rafteikn@rafteikn.is

Geymslur
 Stálhella 18
 221 Hafnarfjörður

Rafkerfi
 Lampaplan
 Hluti 2

HANNAÐ: Amar Bjarnason	TEIKNAD: Amar Bjarnason	YFIRFARID: Amar Bjarnason
DAGS. ÚTG: 06-02-2025	MÆLIKVÆRDI: 1:50	BLADSTÆRÐ: A1
VERKNUMER: 09-25	TEIKNINGANUMER: 01_15_02	ÚTG: A

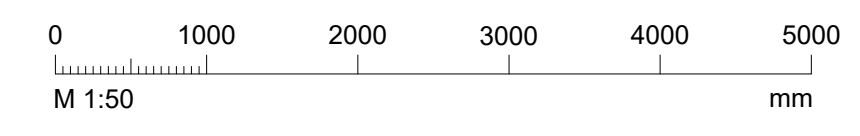

C:\Users\amar\Dropbox\Gæðakerfi112 Rafagnateikningar\Verkefnamppu\060925 (Stálhella 18)\05-Teikningar\28-Bla hella lampaplan.dwg

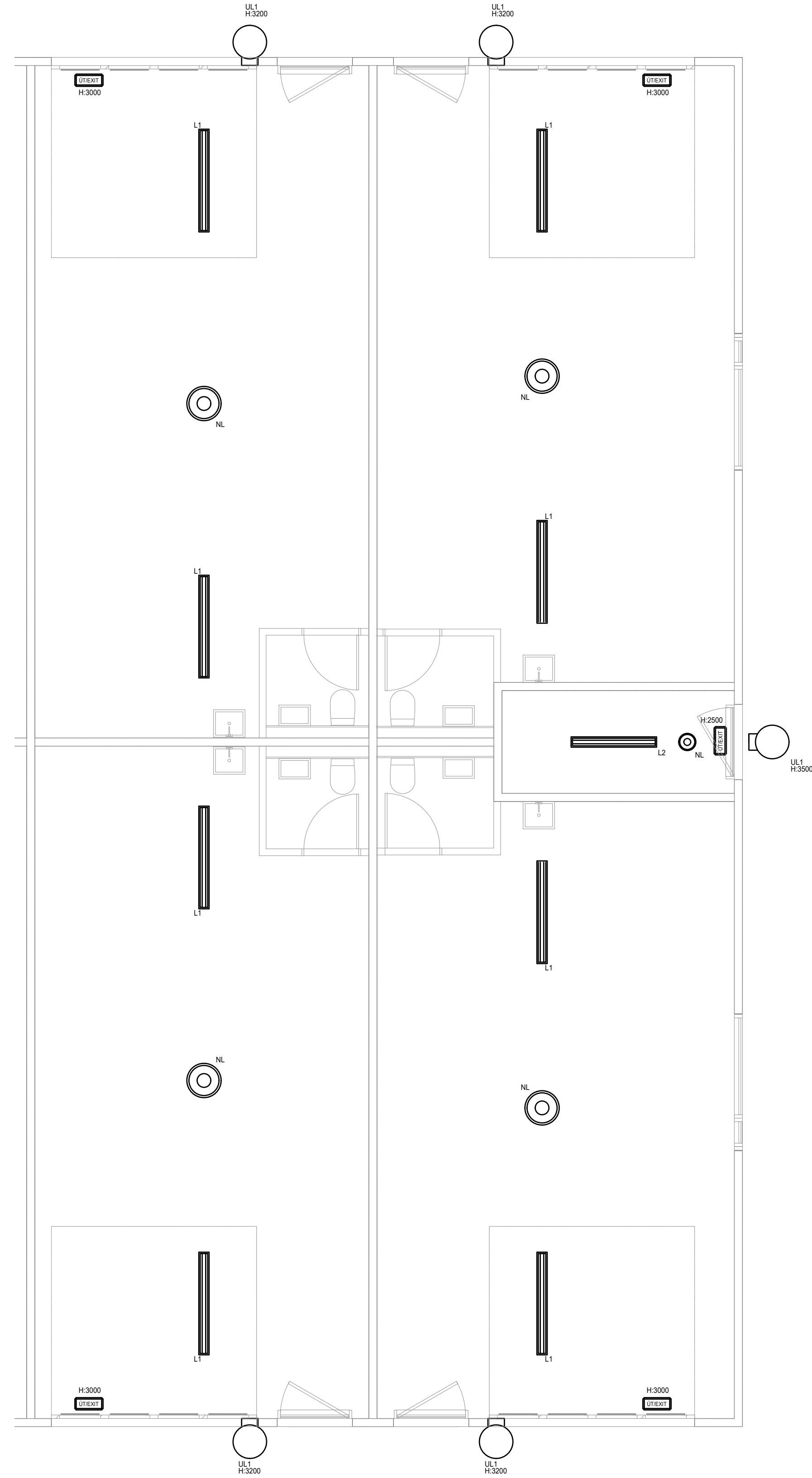
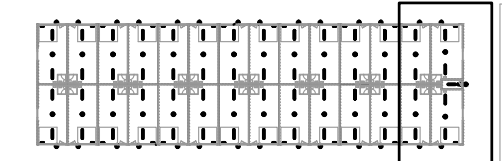

ÚTG.	DAGS.	ÚTGAUFERILL	HANNAÐ	TEIKN.	YFIRF.
---	---	---	---	---	---
---	---	---	---	---	---
---	---	---	---	---	---
---	---	---	---	---	---
---	---	---	---	---	---
---	---	---	---	---	---
---	---	---	---	---	---
---	---	---	---	---	---
---	---	---	---	---	---
---	---	---	---	---	---

TÆKNISÝN
 Rafagnateikningar og hönnun
 Kt: 251191-2639
 Sími: 846-7203
 rafteikn@rafteikn.is

Geymslur
 Stálhella 18
 221 Hafnarfjörður

Rafkerfi
 Lampaplan
 Hluti 3

HANNAÐ: Amar Bjarnason	TEIKNAD: Amar Bjarnason	YFIRFARID: Amar Bjarnason
DAGS. ÚTG: 06-02-2025	MÆLIKVARDI: 1:50	BLADSTÆRB: A1
VERKNUMER: 09-25	TEIKNINGANUMER: 01_15_03	ÚTG: A

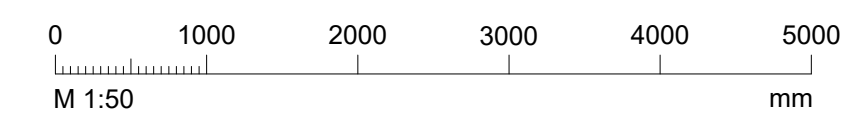

C:\Users\amari\Dropbox\Gæðakerfi112 Rafagnateikningar\Venefhamppur\2025\09-25 (Stálhella 18)\05-Teikningar\28-Bili huli lampaplan.dwg

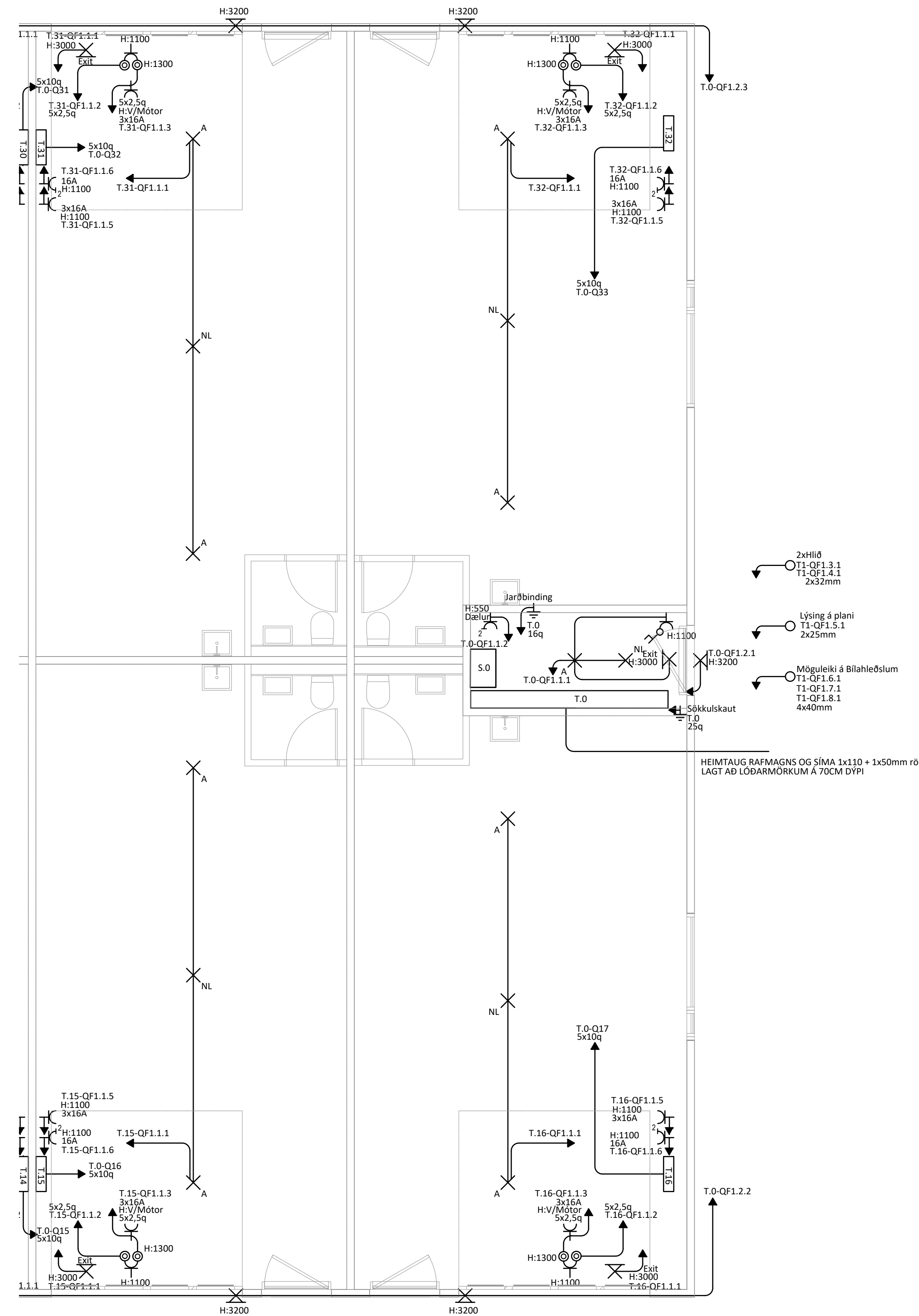
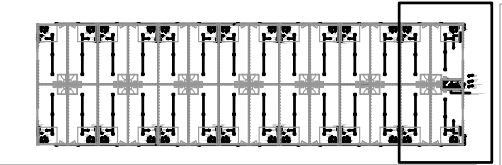

- 2xHl0
T1-QF1.3.1
T1-QF1.4.1
2x32mm
 - Lýsing á plani
T1-QF1.5.1
2x25mm
 - Möguleiki á Bilahleðslum
T1-QF1.6.1
T1-QF1.7.1
T1-QF1.8.1
4x40mm
- HEIMTAUG RAFMAGNS OG SÍMA 1x110 + 1x50mm rör
LAGT AÐ LÖÐARMÖRKUM Á 70CM DÝPI

Hönnunarefni: _____

ÚTG.	DAGS.	ÚTGAUFERILL	HANNAÐ	TEIKN.	YFIRF.

Rafteikn
 Rafteikningar og hönnun
 Kt: 251191-2639
 Sími: 846-7203
 rafteikn@rafteikn.is

TÆKNISÝN
 Geymslur
 Stálhella 18
 221 Hafnarfjörður

Rafkerfi
 Lágspenna
 Hluti 3

HANNAÐ: Amar Bjarnason	TEIKNAD: Amar Bjarnason	YFIRFARID: Amar Bjarnason
DAGS. ÚTG: 06-02-2025	MÆLIKVARDI: 1:50	BLADSTÆRB: A1
VERKNUMER: 09-25	TEIKNINGANUMER: 01_16_03	ÚTG: A

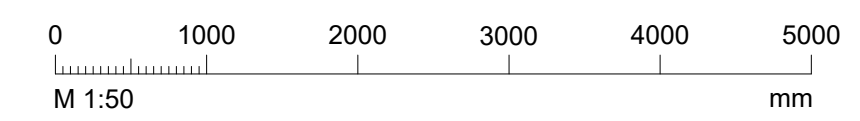

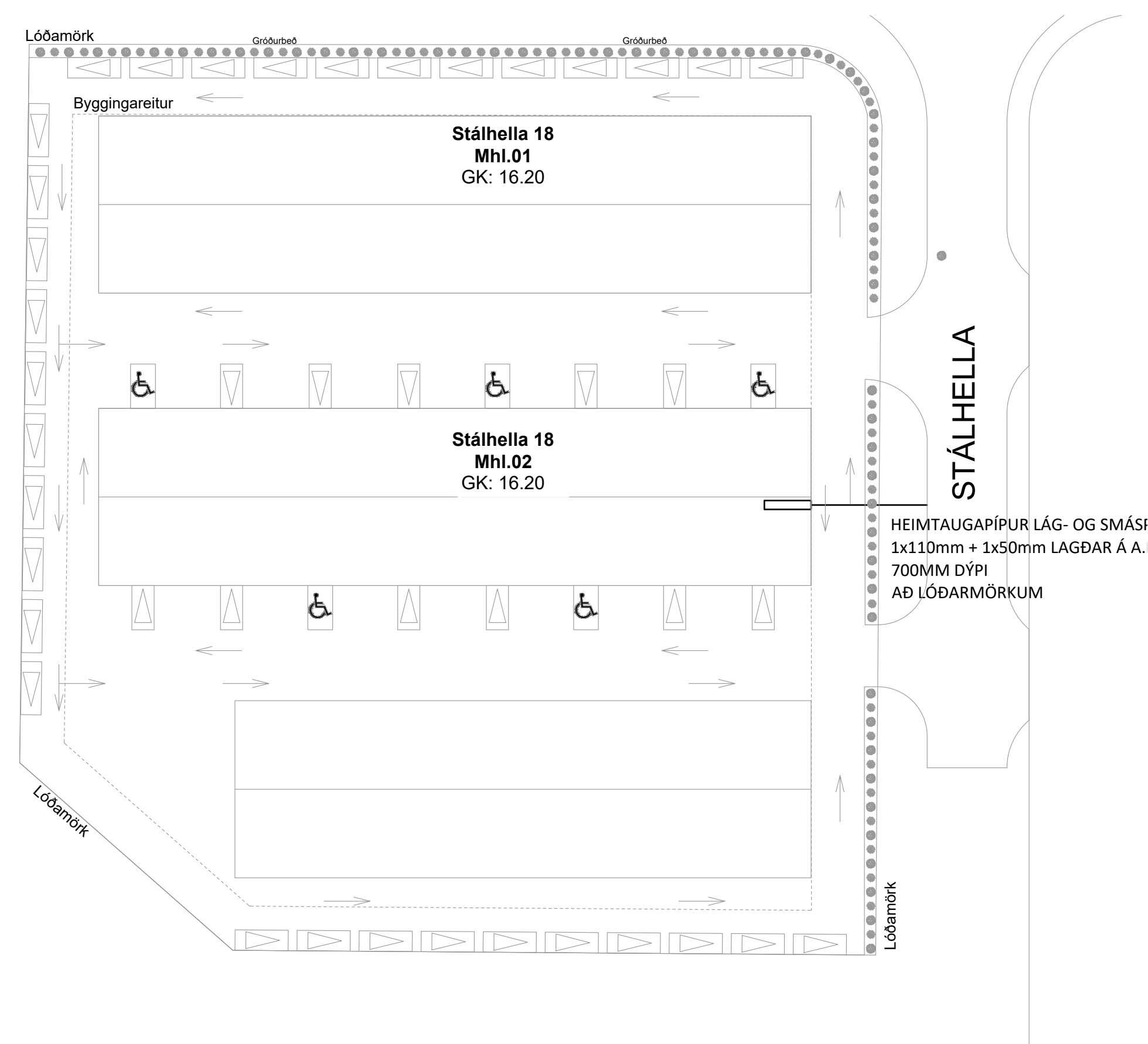

1:500

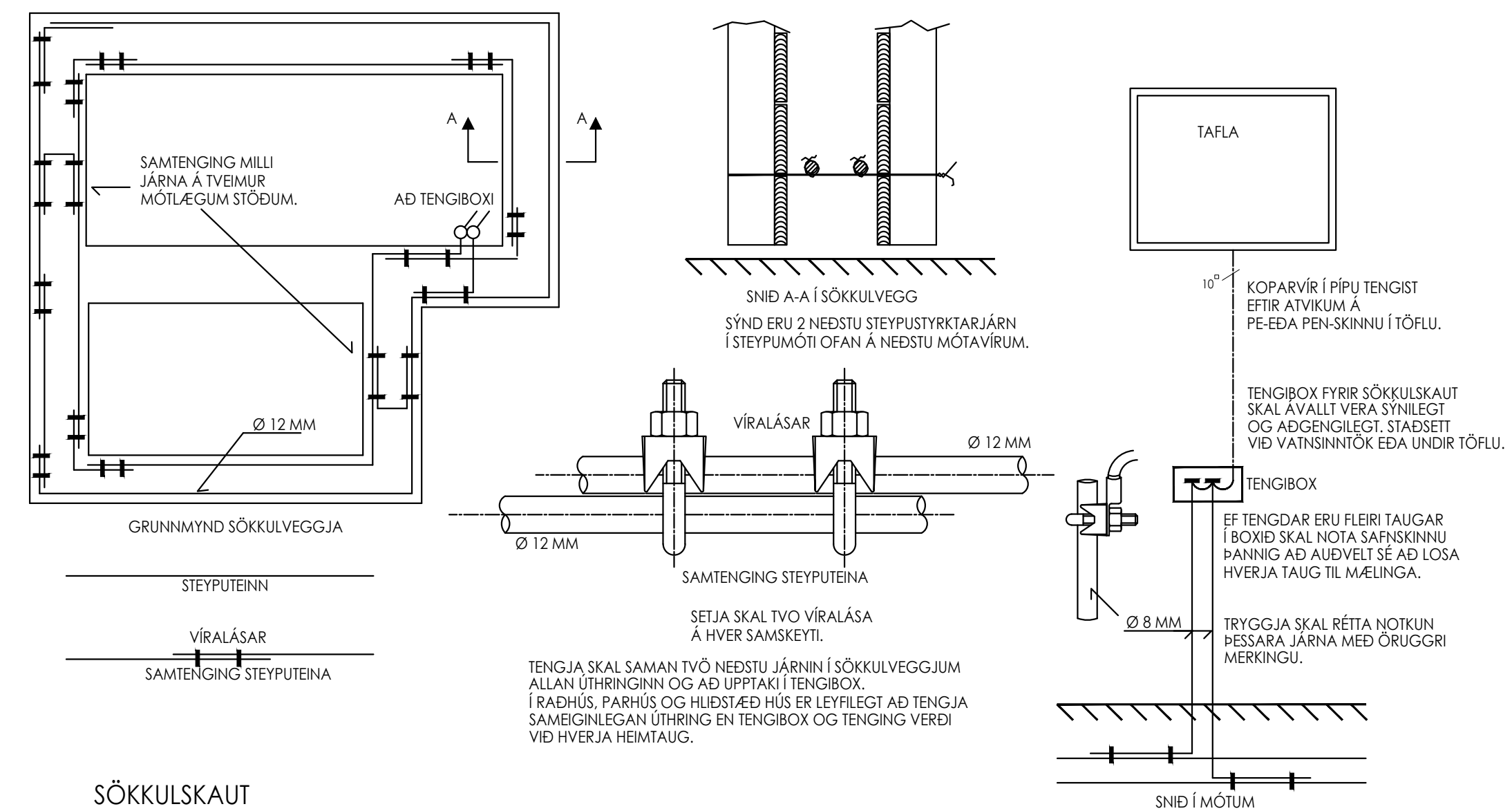

SÖKKULSKAUT

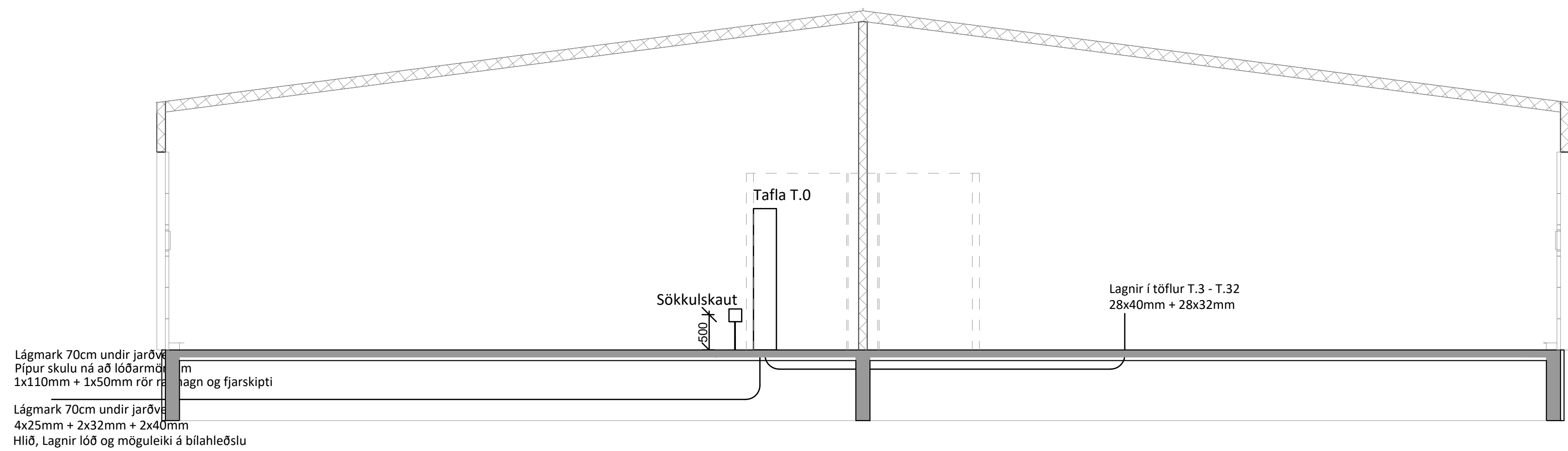

1:50

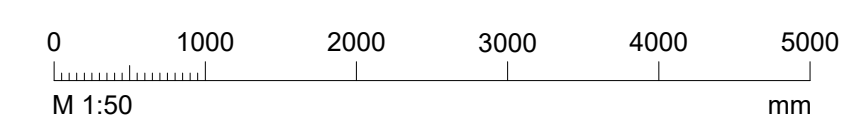

ÚTG.	DAGS.	UTGAFUFERILL	HANNAÐ TEIKN YFIRF.
---	---	---	---
---	---	---	---
---	---	---	---
---	---	---	---
---	---	---	---
---	---	---	---
---	---	---	---
---	---	---	---
---	---	---	---

Rafteikni og Lýsingarhönnun
Kt: 251191-2639
Sími: 846-7203
Raftekni@rafteikni.is

TÆKNISÝN

Geymslur
Stálhella 18
221 Hafnarfjörður

Rafkerfi
Afstöðumynd
Sniðmynd

HANNAÐ:	TEIKNAD:	YFIRFARID:
Arnar Bjarnason	Arnar Bjarnason	Arnar Bjarnason
DAGS. ÚTG:	MÆLIKVARDI:	BLAÐSTÆRD:
06-02-2025	1:50/1:500	A1
VERKNUMER:	TEIKNINGANUMER:	ÚTG:
09-25	XX_23_01	A

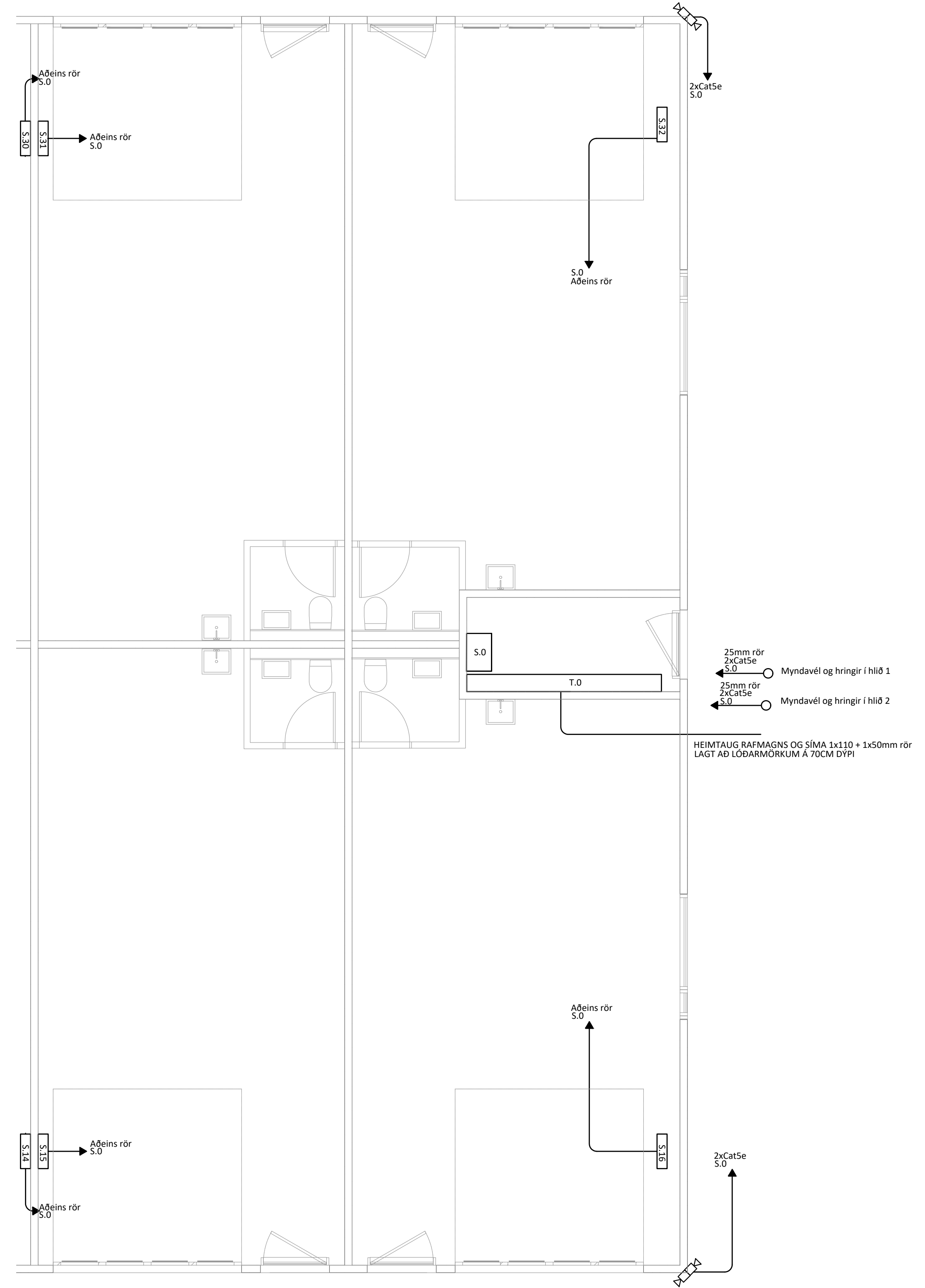
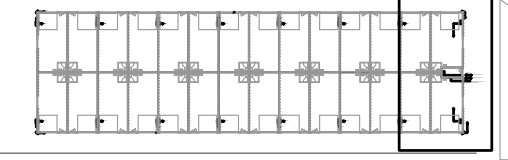

- 25mm rör 2xCat5e S.O Myndavél og hringir í hlöð 1
- 25mm rör 2xCat5e S.O Myndavél og hringir í hlöð 2

HEIMTAUG RAFMAGNS OG SÍMA 1x110 + 1x50mm rör LAGT AÐ LOBARMÖRKUM Á 70CM DYPI

ÚTG.	DAGS.	ÚTGAUFERILL	HANNAÐ	TEIKN.	YFIRF.
—	—	—	—	—	—
—	—	—	—	—	—
—	—	—	—	—	—
—	—	—	—	—	—
—	—	—	—	—	—
—	—	—	—	—	—
—	—	—	—	—	—
—	—	—	—	—	—
—	—	—	—	—	—
—	—	—	—	—	—

TÆKNISÝN
 Raflagnateikningar og hönnun
 Kt: 251191-2639
 Sími: 846-7203
 rafteikn@rafteikn.is

Geymslur
 Stálhella 18
 221 Hafnarfjörður

Rafkerfi
 Smáspenna
 Hluti 3

HANNAÐ: Arnar Bjarnason	TEIKNAD: Arnar Bjarnason	YFIRFARID: Arnar Bjarnason
DAGS. ÚTG: 06-02-2025	MÆLIKVARDI: 1:50	BLADSTÆRB: A1
VERKNUMER: 09-25	TEIKNINGANUMER: 01_31_03	ÚTG: A

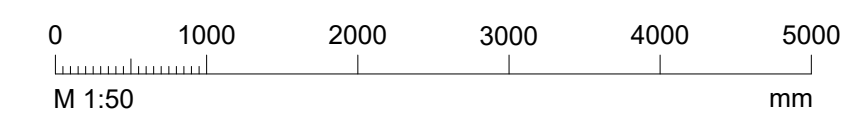

C:\Users\arnar\Dropbox\Gæðakerfi112 Raflagnateikningar\Venefhamppur\2025\09-25 (Stálhella 18)\05-Teikningar\28-Bla hlúð\Smáspenna.dwg

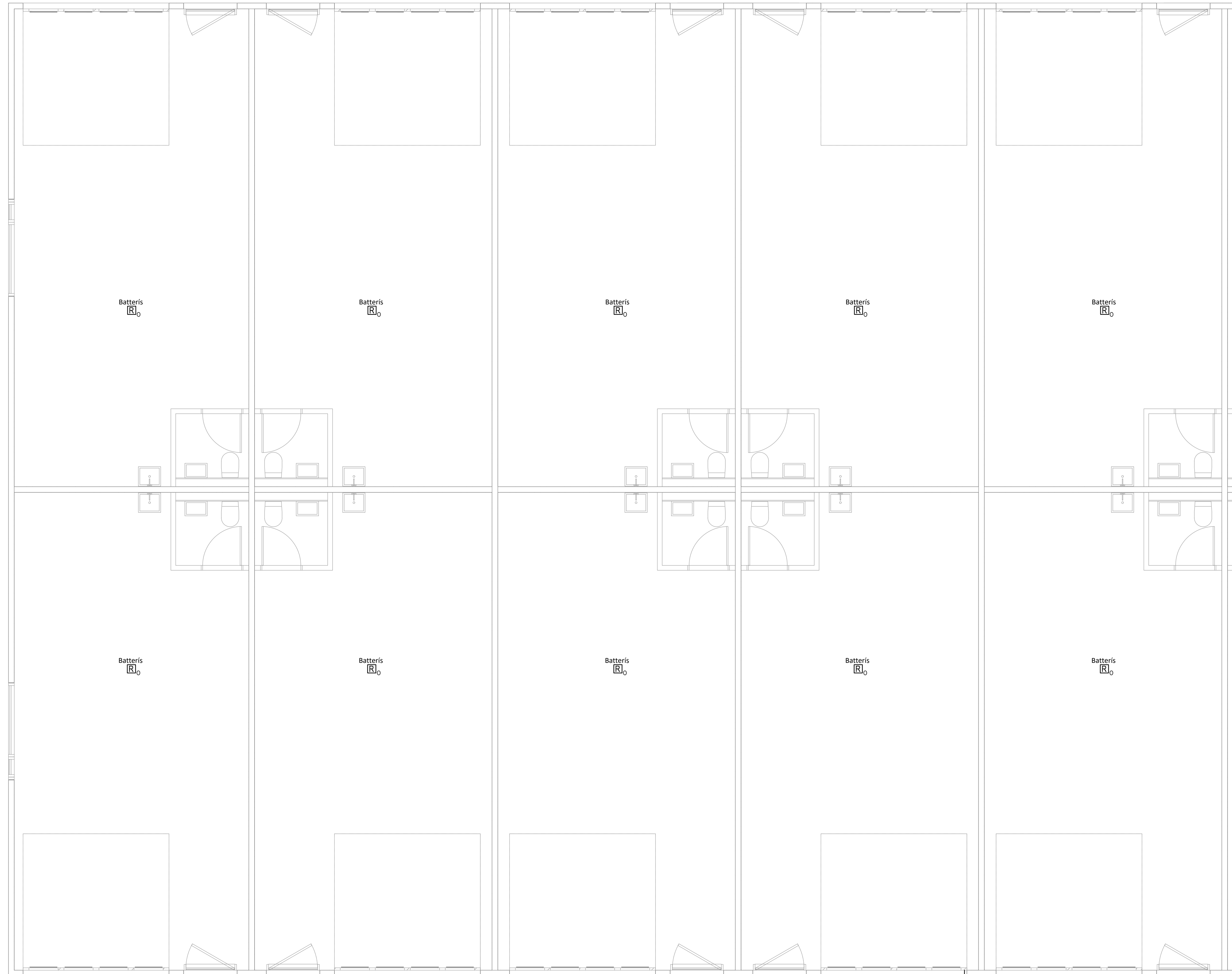
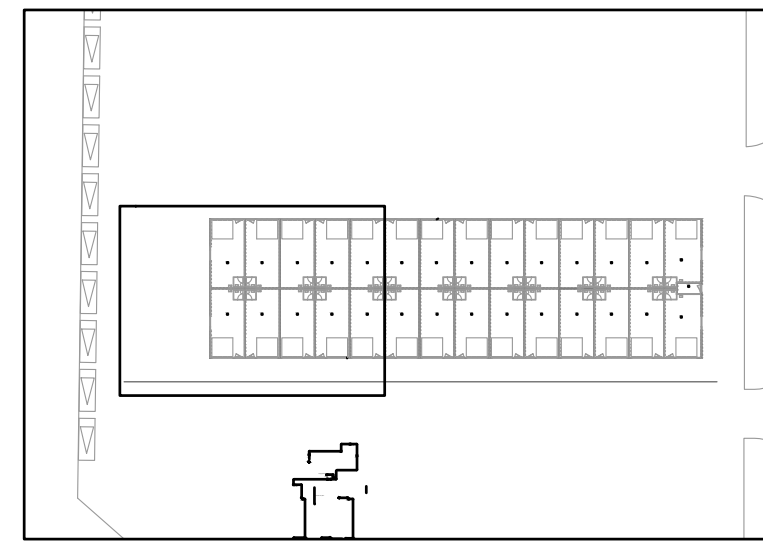

Hönnunarefni: _____

ÚTG.	DAGS.	ÚTGAUFERILL	HANNAÐ	TEIKN.	YFIRF.
—	—	—	—	—	—
—	—	—	—	—	—
—	—	—	—	—	—
—	—	—	—	—	—
—	—	—	—	—	—
—	—	—	—	—	—
—	—	—	—	—	—
—	—	—	—	—	—
—	—	—	—	—	—
—	—	—	—	—	—

TÆKNISÝN
 Raflagnateikningar og hönnun
 Kt: 251191-2639
 Sími: 846-7203
 rafteikn@rafteikn.is

Geymslur
 Stálhella 18
 221 Hafnarfjörður

Rafkerfi
 Bunakerfi
 Hluti 1

HANNAÐ:	TEIKNAD:	YFIRFARID:
Arnar Bjarnason	Arnar Bjarnason	Arnar Bjarnason
DAGS. ÚTG:	MÆLIKVÆRDI:	BLADSTÆRÐ:
06-02-2025	1:50	A1
VERKNUMER:	TEIKNINGANUMER:	ÚTG:
09-25	01_34_01	A

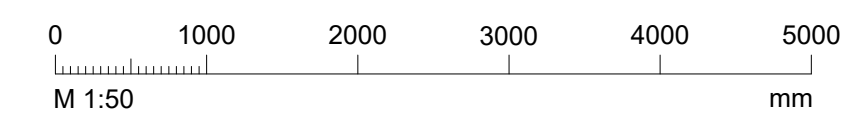



Motttekið
Hafnarfjörður
Byggingarfulltrúi

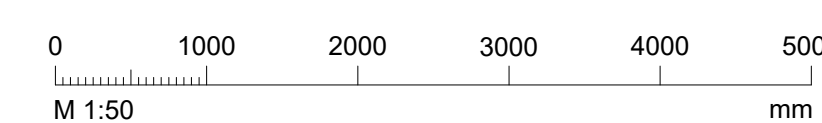
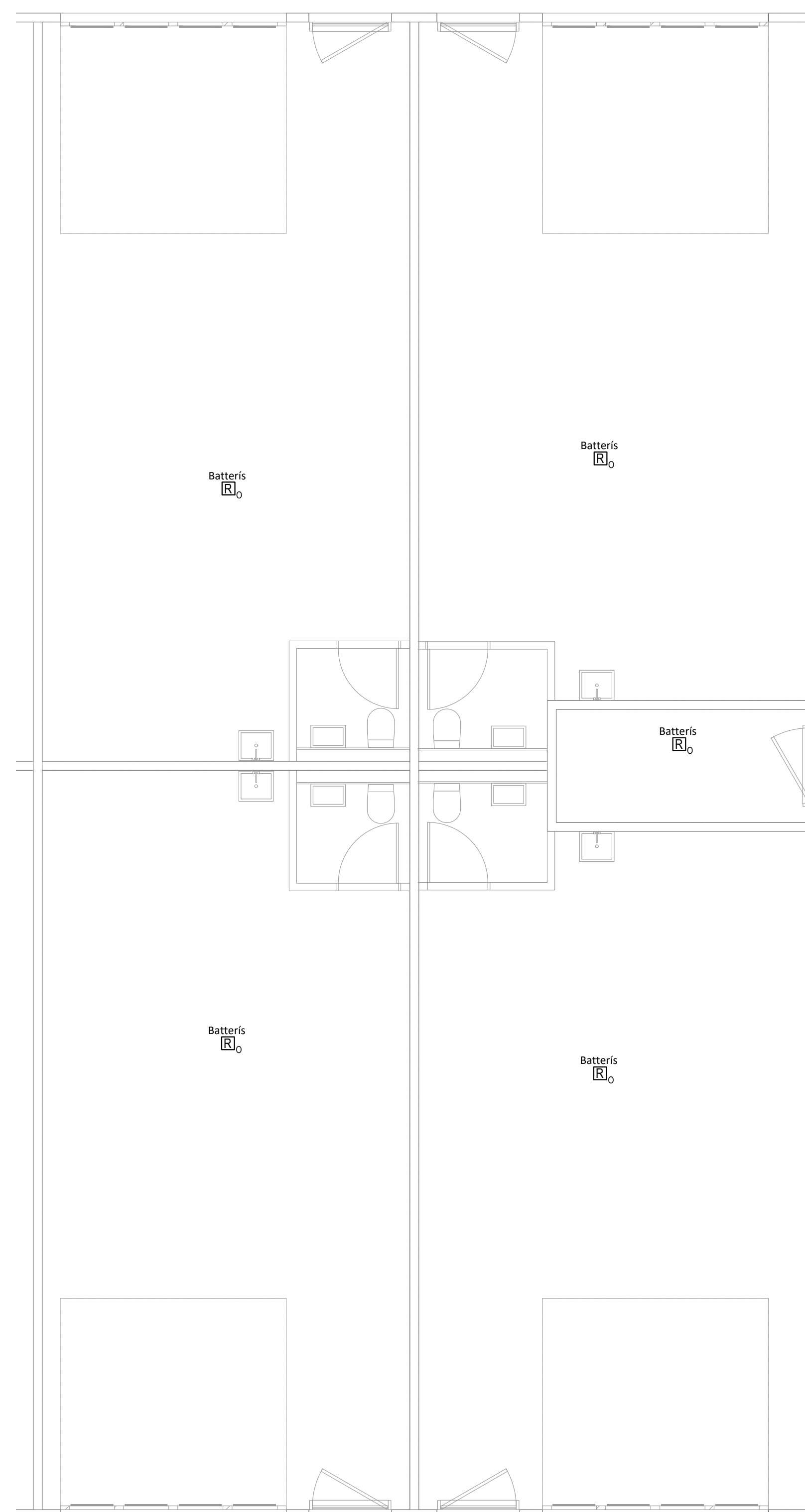

Hönnunarefni: _____

ÚTG.	DAGS.	ÚTGAUFERILL	HANNAÐ	TEIKN.	YFIRF.
---	---	---	---	---	---
---	---	---	---	---	---
---	---	---	---	---	---
---	---	---	---	---	---
---	---	---	---	---	---
---	---	---	---	---	---
---	---	---	---	---	---
---	---	---	---	---	---
---	---	---	---	---	---
---	---	---	---	---	---



Raflagnateikningar og hönnun
Kt: 251191-2639
Sími: 846-7203
rafteikn@rafteikn.is

Geymslur
Stálhella 18
221 Hafnarfjörður

Rafkerfi
Bunakerfi
Hluti 3

HANNAÐ: Arnar Bjarnason	TEIKNAD: Arnar Bjarnason	YFIRFARID: Arnar Bjarnason
DAGS. ÚTG: 06-02-2025	MÆLIKVÆRDI: 1:50	BLADSTÆRÐ: A1
VERKNUMER: 09-25	TEIKNINGANUMER: 01_34_03	ÚTG: A

Dagsetning aðaluppráttar: 1/06-02-2025
Hönnuður: Arnar Bjarnason 2511912639

